

INDUSTRIAL

**FLOOR
GRES** 

MADE IN FLORIM

IVORY



TAUPE



MOKA



SAGE



STEEL



PLOMB



6

COLOURS



soft

matte

**bush
hammered**

3 SURFACES

PLUS

Cambiano le prospettive del progetto contemporaneo: dimensioni sorprendenti in soli 6 mm di spessore, leggero, versatile, resistente, esteticamente fuori dall'ordinario.

Il più grande formato che si sia mai visto.

Modern design perspectives are changing: Amazing sizes in a thickness of just 6 mm, light, versatile and strong, with extraordinary aesthetic appeal.

The largest size ever seen.

Les perspectives de la conception contemporaine évoluent : dimensions surprenantes 6 mm d'épaisseur seulement, léger, polyvalent, résistant, esthétique originale.

Le plus grand format jamais réalisé.

Die Perspektiven der heutigen Projekts ändern sich: überraschende Größen mit nur 6 mm Stärke, leicht, vielseitig, widerstandsfest, außergewöhnlich schön und natürlich.

Das größte Format, das bislang produziert wurde.

Cambia el panorama del diseño contemporáneo: tamaño sorprendente en sólo 6 mm de espesor, ligero, versátil, resistente, estéticamente fuera de lo común.

El formato más grande que se haya visto.

Современный дизайн покоряет новые горизонты: грандиозные размеры при толщине всего 6 мм, легкость, универсальность, прочность, неординарная эстетика.

Самый большой формат, когда-либо существовавший в мире.

Grandissimi formati, fino a 160x320 cm. Soli 6 mm di spessore. Possibilità di tagli di qualsiasi forma e dimensione. Facile da trasportare e movimentare. Posa sia a pavimento che a rivestimento. Elevata resa estetica. Notevole resistenza alle sollecitazioni.

Extra-large sizes, up to 160x320 cm. Only 6 mm thick. Possibility of cutting any shape and size. Easy transport and handling. Laying on both floors and walls. High aesthetic yield. Considerable stress resistance.

Très grands formats, jusqu'à 160x320 cm. 6 mm d'épaisseur seulement. Possibilité de coupe de tous formats et dimensions. Transport et manutention faciles. Pose murale et au sol. Rendu esthétique élevé. Résistance importante aux sollicitations.

Ultragroße Formate, bis zu 160x320 cm. Nur 6 mm Stärke. Die Möglichkeit, jede beliebige Form und Größe zu schneiden. Leicht zu transportieren und zu handhaben. Verlegung sowohl am Boden als auch an der Wand. Hoher ästhetischer Anspruch. Beachtliche Resistenz gegen Beanspruchungen.

Formatos muy grandes, de hasta 160x320 cm. Sólo 6 mm de espesor. Posibilidad de cortes de cualquier forma y tamaño. Fácil de transportar y manejar. Colocación en pavimentos y revestimientos. Altos resultados estéticos. Considerable resistencia a las tensiones.

Мега-форматы до 160x320 см. Толщина всего 6 мм. Возможность резки до любой формы и размеров. Простота транспортировки и перемещения. Возможность покрытия пола и облицовки стен. Восхитительная эстетика. Впечатляющие прочностные характеристики.

160x320
63"x126"



120x280
47^{1/4}"x110^{1/4}"



120x240
47^{1/4}"x94^{1/2}"



120x240 (R+PTV)
47^{1/4}"x94^{1/2}"



160x160
63"x63"



120x120
47^{1/4}"x47^{1/4}"



120x120 (R+PTV)
47^{1/4}"x47^{1/4}"



60x120
23^{5/8}"x47^{1/4}"



80x80
31^{1/2}"x31^{1/2}"



**Modernità e semplicità caratterizzate da linee
lineare che si esprime attraverso**

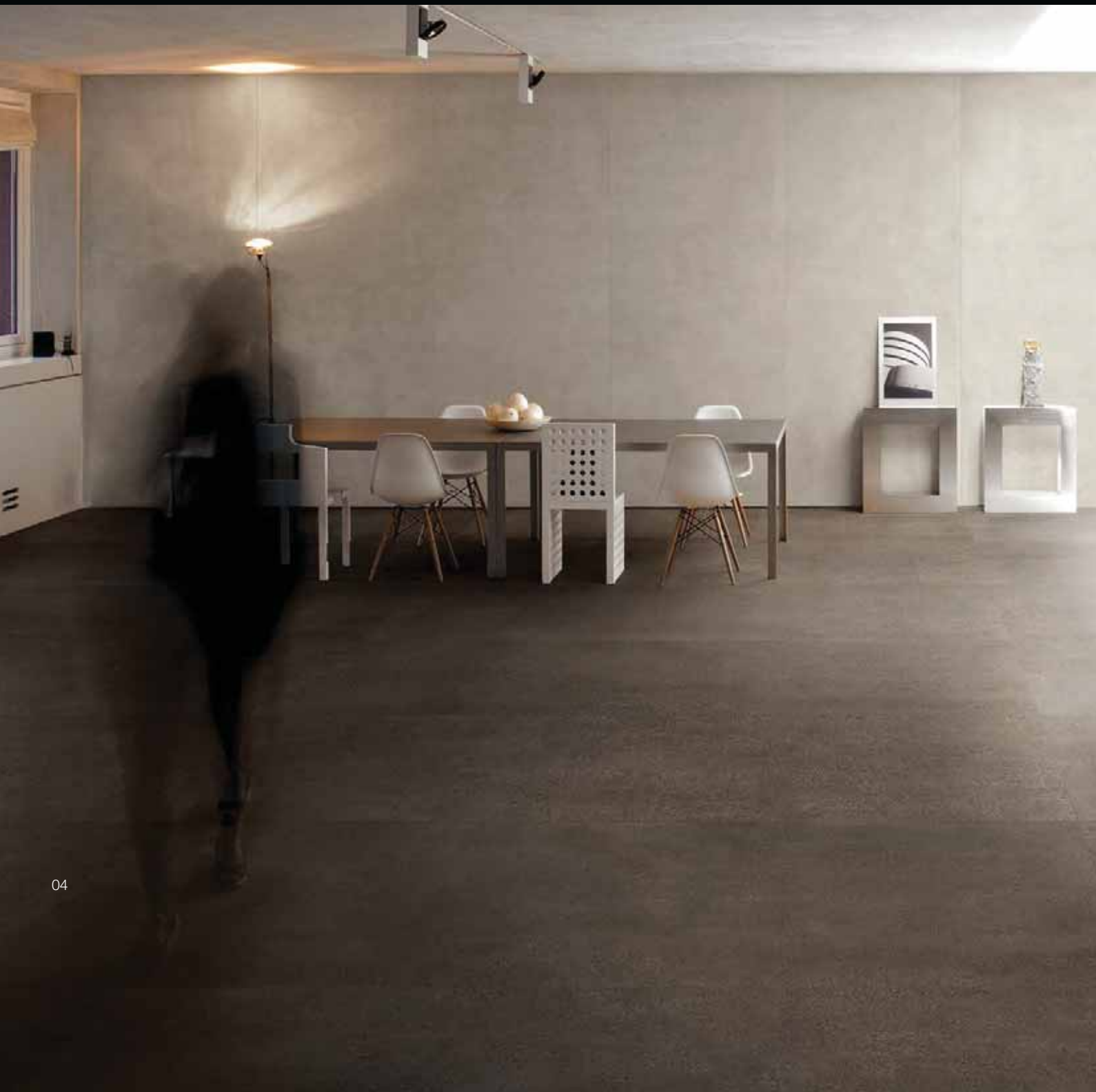

04

MOKA/IVORY

zzano questa superficie neutra e
un mix di colori, formati e decori.



05



INDUSTRIAL/

This neutral and linear surface is distinguished for being modern and simple, expressing itself through a mix of colours, sizes and decorations. Industrial presents itself in its purest form, to be used across the board, efficiently and captivantly, in every architectural project. The innovative 120x240 size allows spaces to be conceived with a brand new vision that clearly displays its matrix of inspiration.

INDUSTRIAL/

Modernité et simplicité caractérisent cette surface neutre et linéaire qui s'exprime dans un mélange de coloris, de formats et de décors. Efficace et captivante dans tous les projets d'architecture, Industrial se propose dans sa forme pure pour être utilisée de façon transversale. Son format innovateur 120x240 permet de concevoir l'espace avec une vision inédite qui démontre clairement son modèle d'inspiration.

INDUSTRIAL/

Modernität und Einfachheit kennzeichnen diese neutrale und lineare Oberfläche, die sich durch einen Mix aus Farben, Formaten und Dekoren ausdrückt. Industrial bietet sich in seiner puren Form an, um übergreifend, effizient und ansprechend in jedem Architekturprojekt verwendet werden zu können. Das innovative Format 120x240 ermöglicht es, den Raum mit einer neuartigen Vision zu konzipieren, die deutlich ihren inspirierenden Ursprung zeigt.

INDUSTRIAL/

Esta superficie neutra y lineal, que se expresa a través de una mezcla de colores, formatos y decoraciones, se caracteriza por su gran modernidad y simplicidad. Industrial se propone en su forma pura, para ser usada transversalmente, eficaz y fascinante en cualquier proyecto de arquitectura. El innovador formato 120x240 permite concebir el espacio con una visión inédita, que muestra claramente su matriz inspiradora.

INDUSTRIAL/

Современность и простота являются характерными чертами этой нейтральной и линейной поверхности, которая находит своё выражение в смешении цветов, форматов и декоративных отделок. Industrial предлагает себя в чистой форме, для использования во взаимопересекающихся решениях, будучи эффективным и приятным в любом из архитектурных проектов. Инновационный формат 120x240 позволяет по-новому воспринять пространство, с новой точки зрения, в которой хорошо виден источник вдохновения.



INDUSTRIAL/

si propone nella sua forma pura, per essere
accattivante in ogni progetto di architettura
concepire lo spazio con una visione inedita che



08

floor: MOKA 120x240 - 47^{1/4}"x94^{1/2}"

wall: IVORY 120x240 - 47^{1/4}"x94^{1/2}" / DECORO A+B IVORY/TAUPE 30x30 - 11^{3/4}"x11^{3/4}"

FLORIM OVERSIZE

magnlum[®]

re utilizzata in modo trasversale, efficace e
n. L'innovativo formato 120x240 permette di
e mostra chiaramente la sua matrice ispirativa.





10

wall: IVORY 120x240 - 47^{1/4}"x94^{1/2}"

IVORY

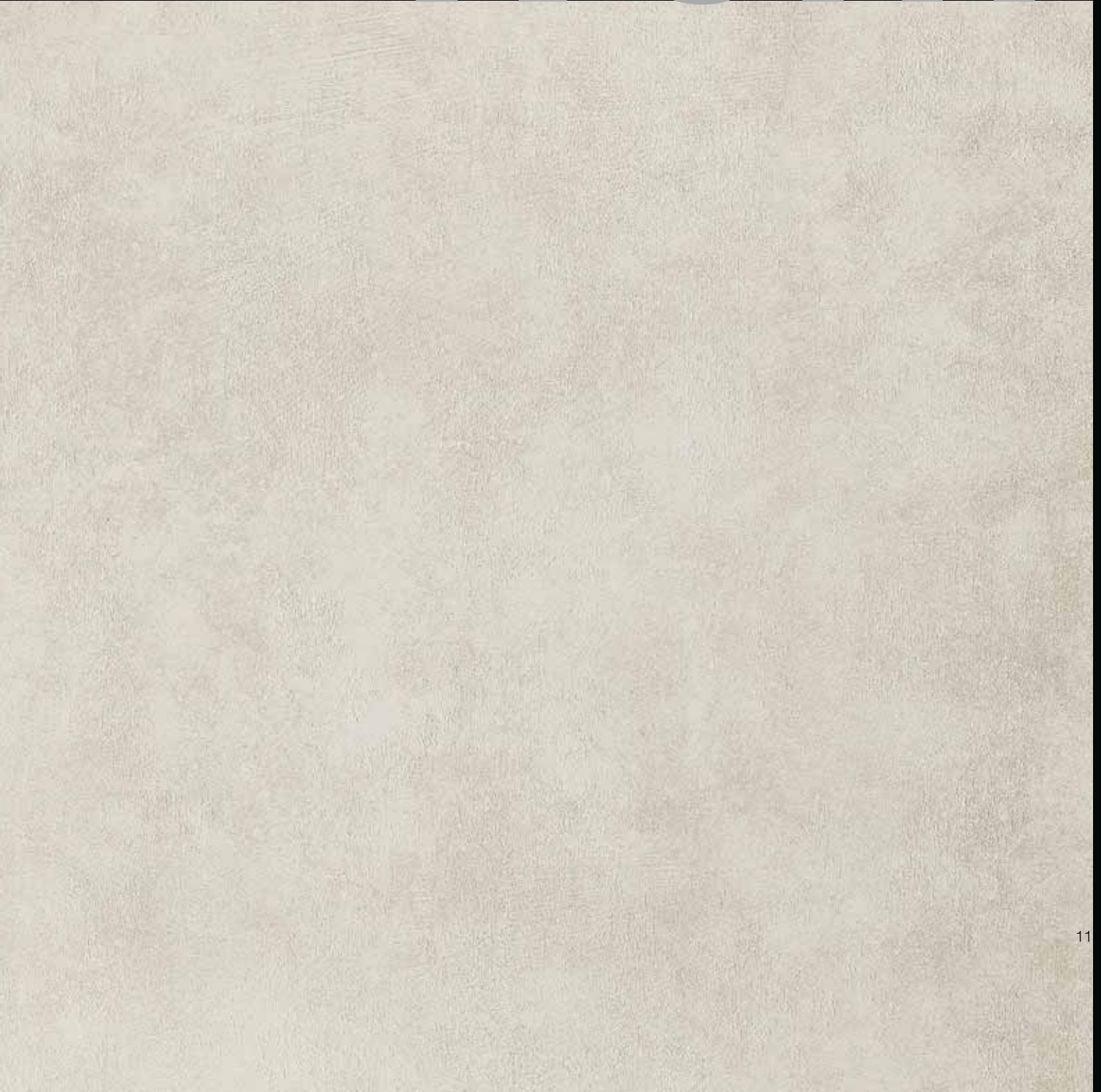

11

NATURALE





















STEEL

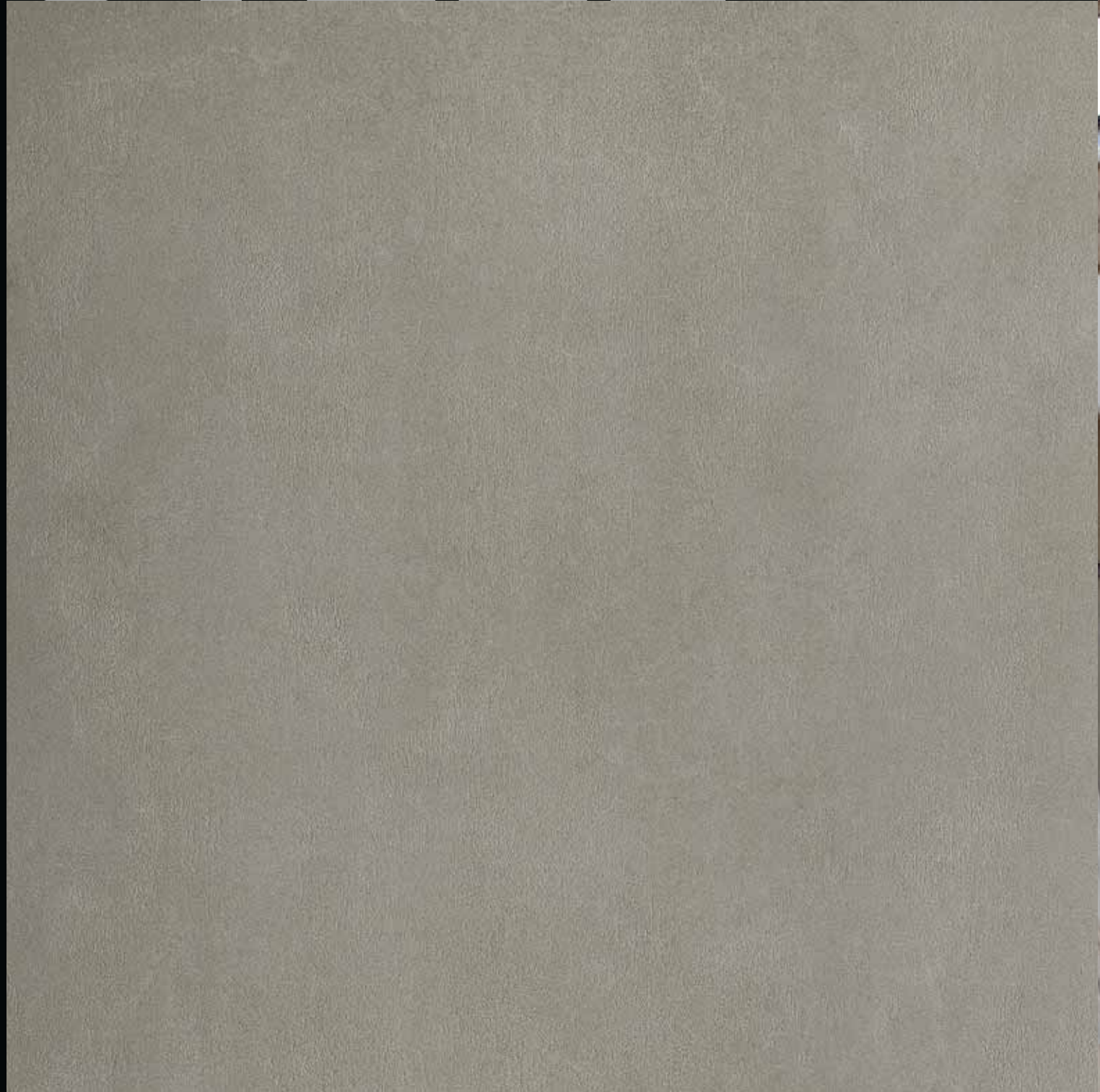

SOFT









SAGE



SOFT







30

floor: PLOMB 30x60 - 11^{3/4}"x23^{5/8}" / PLOMB GRADINO 33x120 - 13"x47^{1/4}"
wall: LISTELLO SFALSATO MIX 3D IVORY-MOKA-TAUPE 15x60 soft - 5^{7/8}"x23^{5/8}"



IVORY-MOKA-TAUPE











IVORY

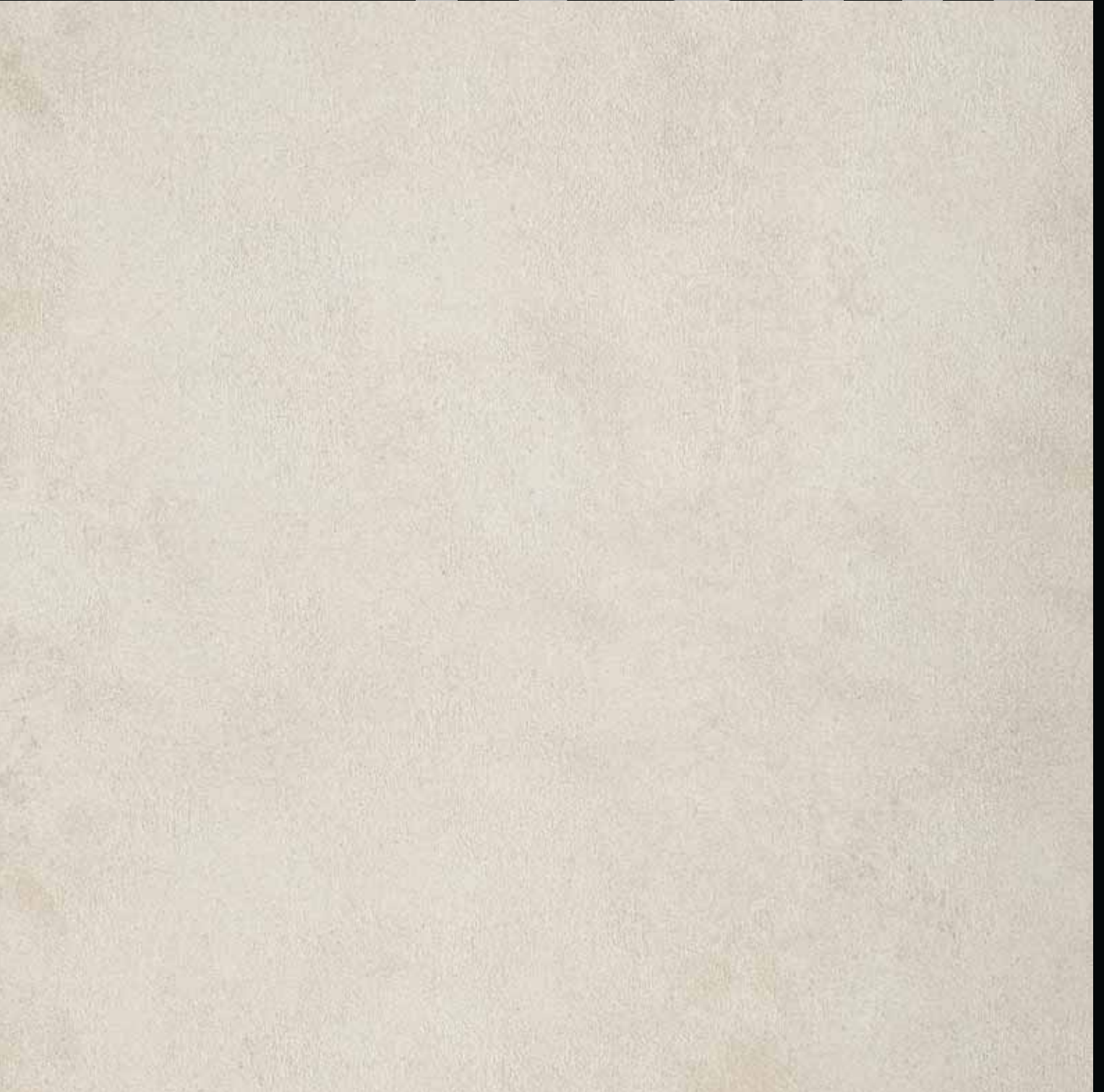

MATTE







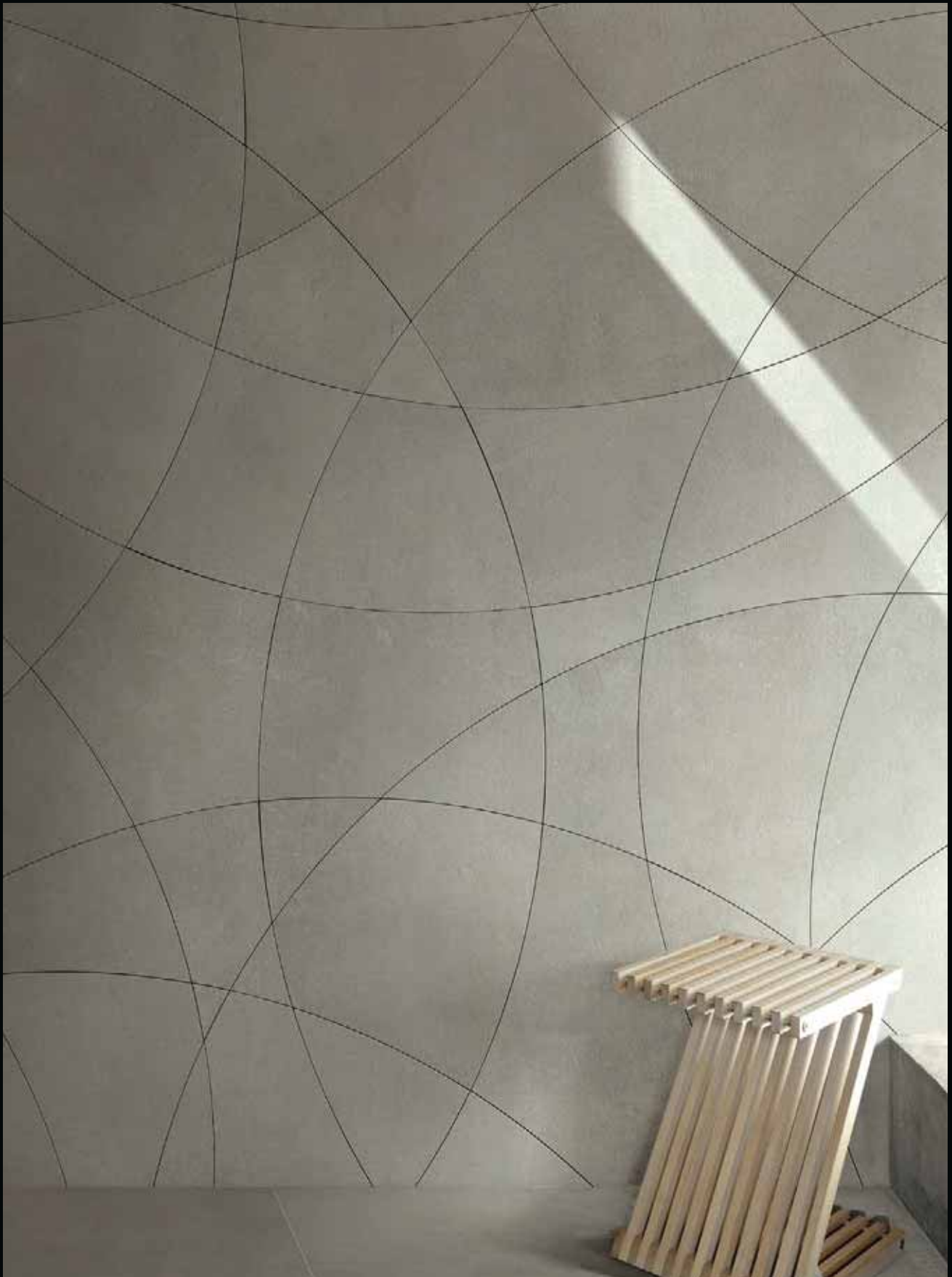





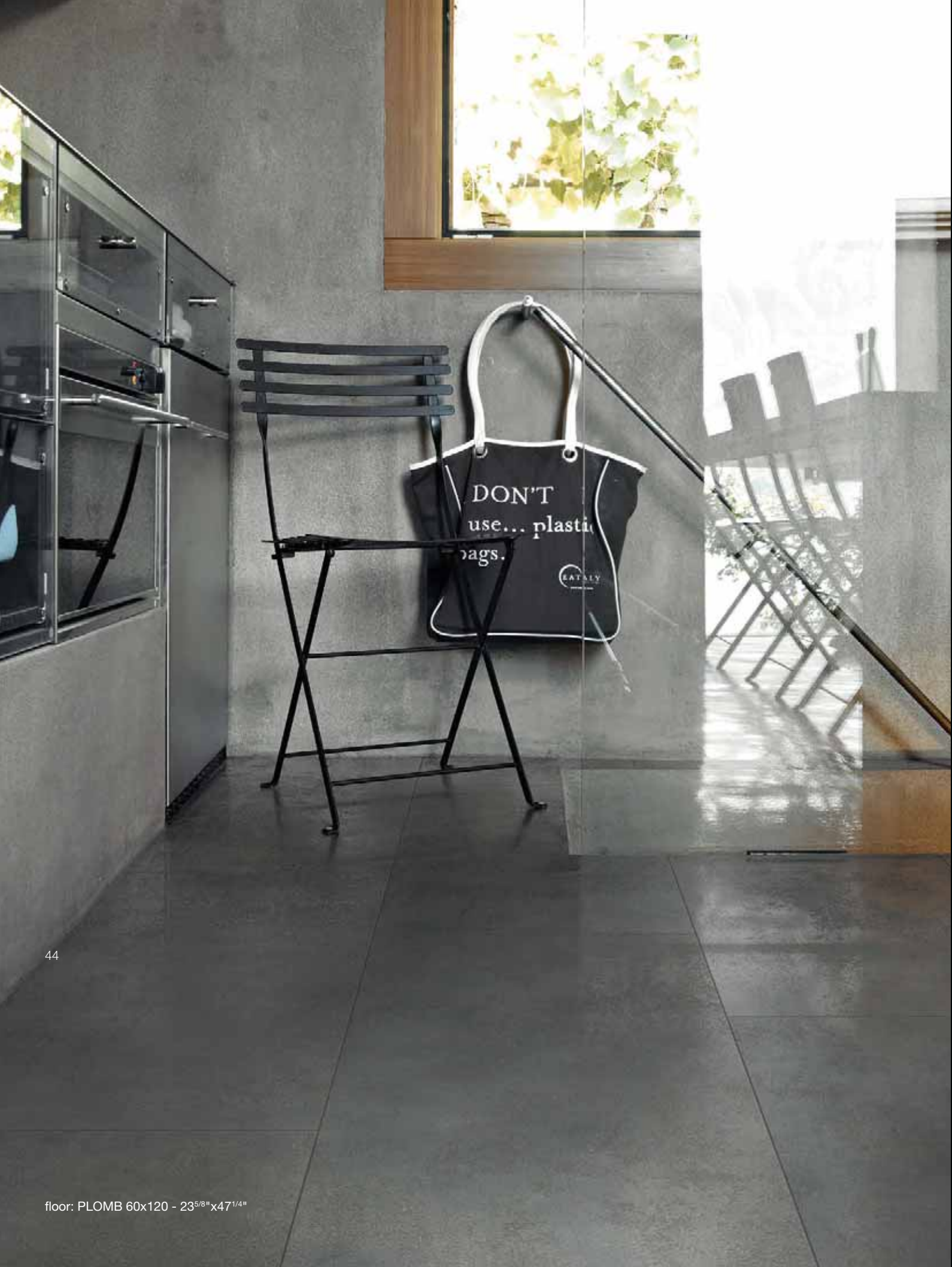









TAUPE

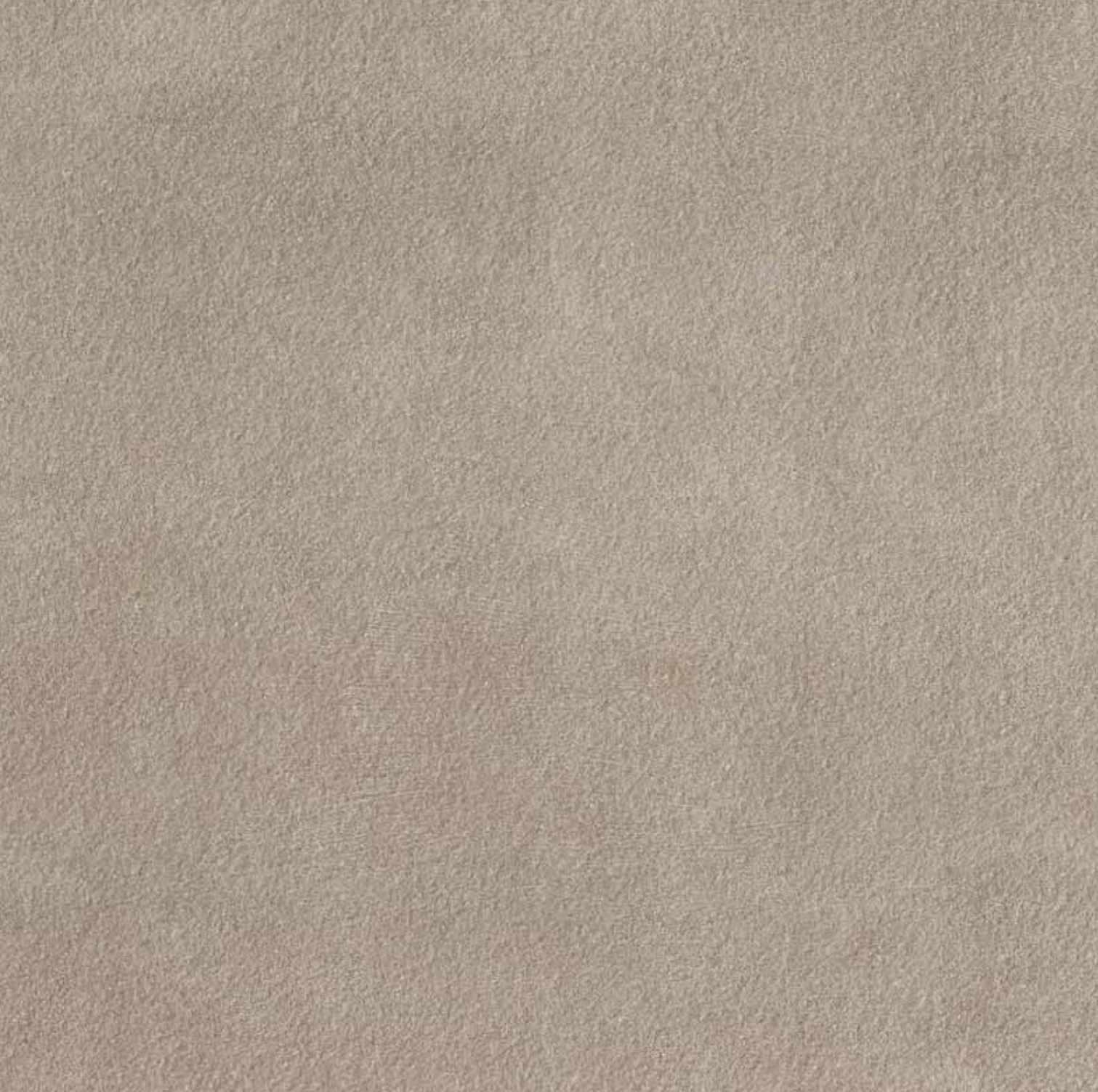

**BUSH
HAMMERED**



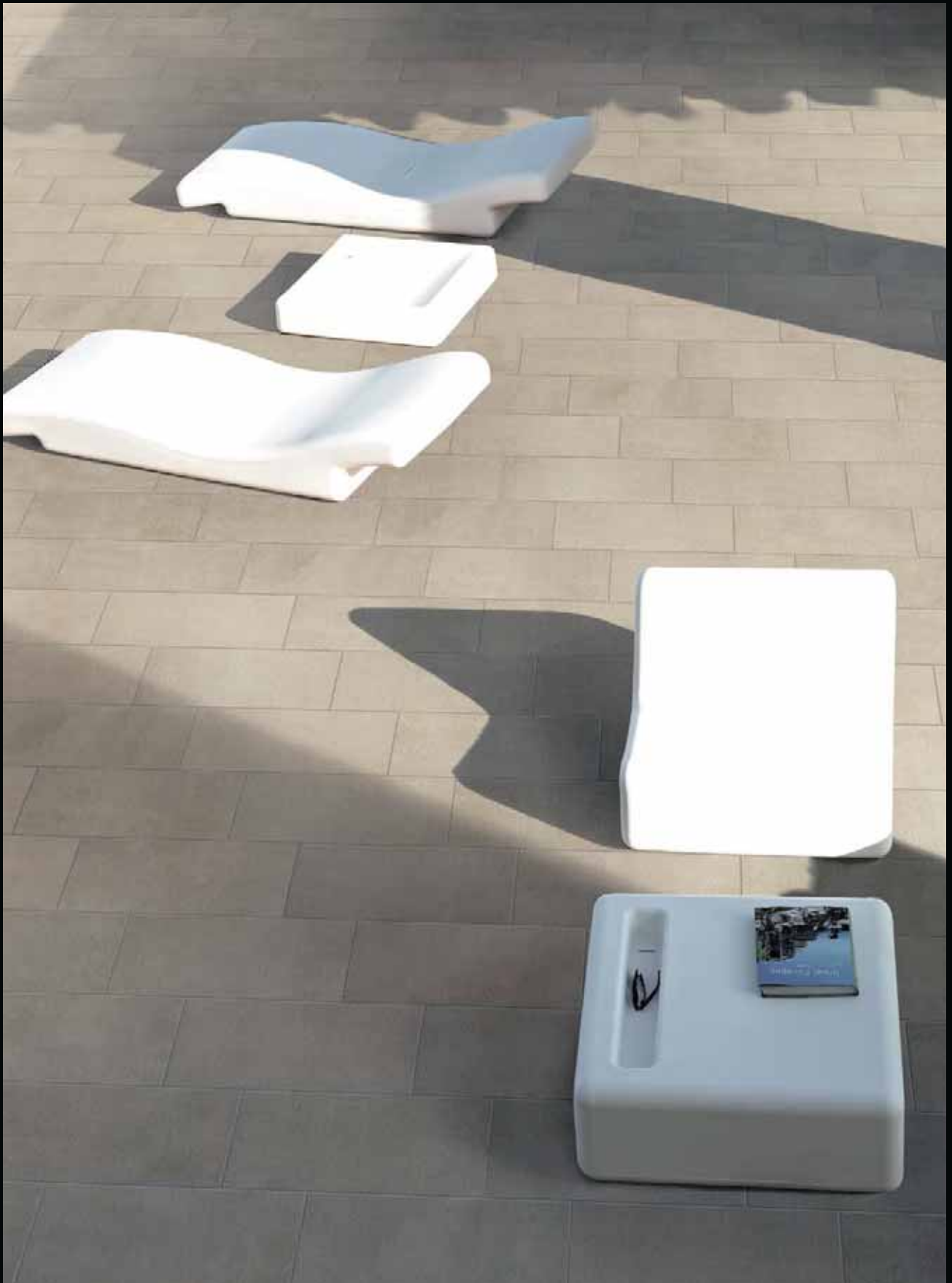

SI

INDUSTRIAL/ INDOOR/OUTDOOR:

**60x120/80x80/40x80/20x80/60x60/30x60 # 1 CM
60x60 # 2 CM**

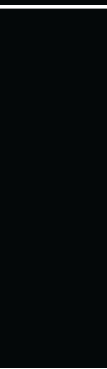
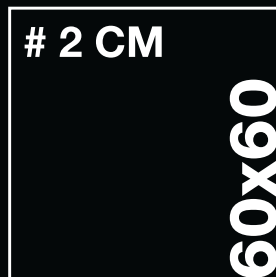

ZEE'S

80x80

40x80

20x80

60x60

30x60



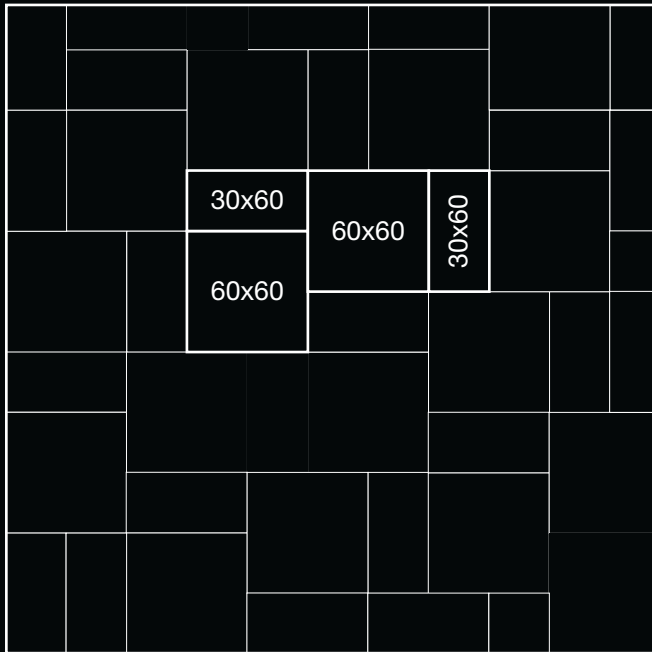

Mod. A - 2 formati

30x60 11^{3/4}"x23^{5/8}" / 33,33 %

60x60 23^{5/8}"x23^{5/8}" / 66,66 %

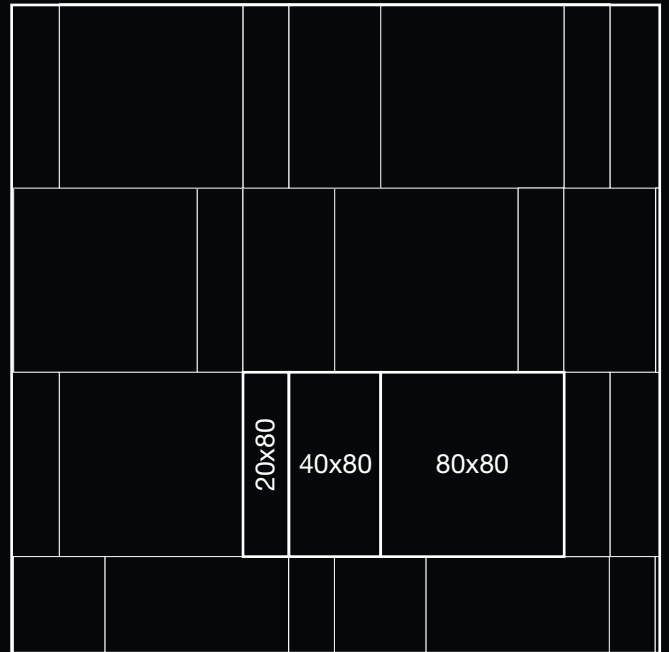

Mod. B - 3 formati

20x80 7^{7/8}"x31^{1/2}" / 14,29 %

40x80 15^{3/4}"x31^{1/2}" / 28,58 %

80x80 31^{1/2}"x31^{1/2}" / 57,13 %

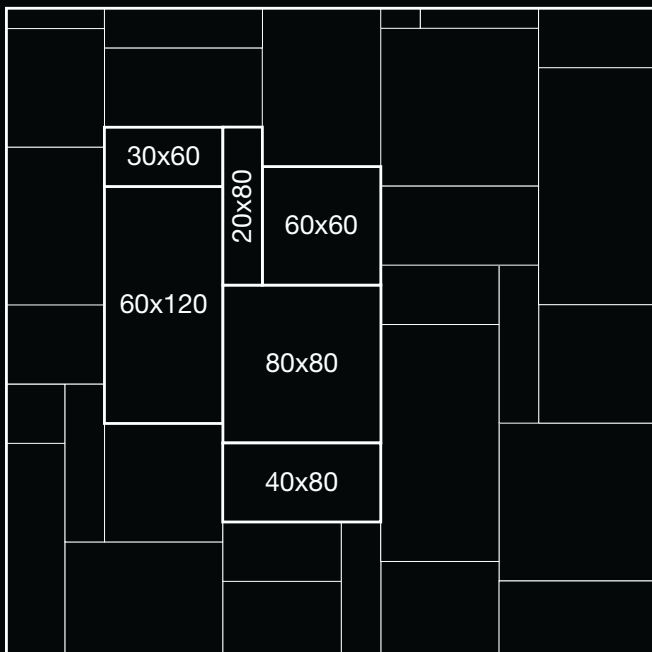

Mod. C - 6 formati

60x120 23^{5/8}"x47^{1/4}" / 30,25 %

30x60 11^{3/4}"x23^{5/8}" / 7,56 %

60x60 23^{5/8}"x23^{5/8}" / 15,12 %

20x80 7^{7/8}"x31^{1/2}" / 6,72 %

80x80 31^{1/2}"x31^{1/2}" / 26,90 %

40x80 15^{3/4}"x31^{1/2}" / 13,45 %

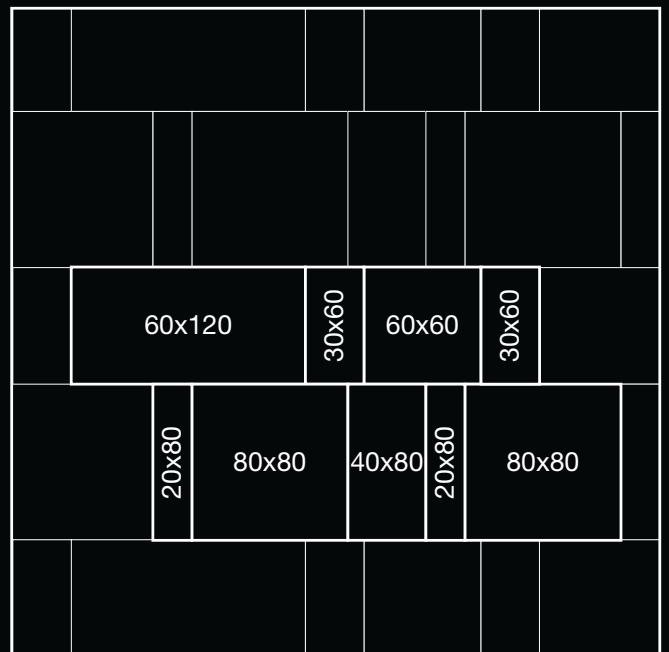

Mod. D - 6 formati

60x120 23^{5/8}"x47^{1/4}" / 21,46 %

30x60 11^{3/4}"x23^{5/8}" / 10,71 %

60x60 23^{5/8}"x23^{5/8}" / 10,71 %

20x80 7^{7/8}"x31^{1/2}" / 9,52 %

80x80 31^{1/2}"x31^{1/2}" / 38,10 %

40x80 15^{3/4}"x31^{1/2}" / 9,52 %

FLORIM COLOR SYSTEM.

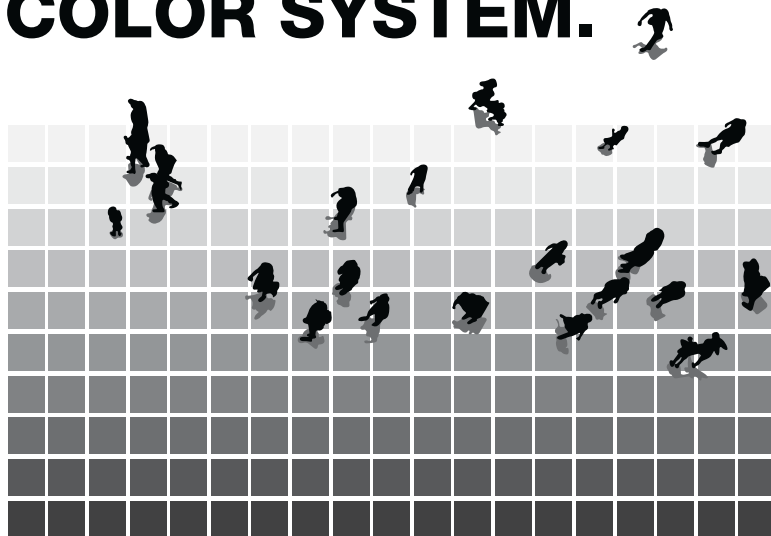

In armonia con la visione che supera i tradizionali confini e le barriere tra le collezioni, Floor Gres progetta la propria palette cromatica sulla base di un piano-colore elaborato considerando l'evoluzione dello stile e le tendenze dell'architettura: il **Florim Color System**. Questo sistema garantisce la compatibilità cromatica tra materiali appartenenti a collezioni diverse. L'architetto sceglie e combina i materiali Floor Gres secondo le proprie esigenze, trovandoli perfettamente compatibili.

Consistent with the vision that stretches beyond traditional boundaries and barriers between collections, Floor Gres designs its color ranges on the basis of a general color plan drawn up taking into consideration the evolution of style and architectural trends: the **Florim Color System**. This system ensures the color compatibility between materials belonging to different collections. The architect selects the Floor Gres materials according to his/her needs and finds them perfectly compatible.

En harmonie avec une vision qui dépasse les frontières traditionnelles et les barrières entre les collections, Floor Gres projette ses gammes de couleurs sur la base d'un plan-couleur général, élaboré en considérant l'évolution du style et les tendances de l'architecture : le **Florim Color System**. Ce système garantit la compatibilité chromatique entre des matériaux appartenant à des collections différentes. L'architecte choisit et combine les matériaux Floor Gres selon ses exigences, et il les trouve parfaitement compatibles.

In Harmonie mit der Vision, die die herkömmlichen Abgrenzungen und Schranken zwischen den Kollektionen überschreitet, plant Floor Gres seine Farbpaletten auf der Grundlage eines allgemeinen Farbprojekts, das unter Berücksichtigung der Entwicklung des Stils und der architektonischen Trends erarbeitet wurde: dem **Florim Color System**. Dieses System garantiert die farbliche Kompatibilität der Materialien unterschiedlicher Kollektionen. Der Architekt wählt und kombiniert die Materialien von Floor Gres seinen Bedürfnissen entsprechend, und stellt fest, dass sie perfekt kompatibel sind.

De acuerdo con la visión que supera las barreras y los confines tradicionales entre las colecciones, Floor Gres proyecta sus gamas y colores en base a un plan de color general elaborado considerando la evolución del estilo y las tendencias de la arquitectura: el **Florim Color System**. Este sistema garantiza la compatibilidad cromática entre los materiales pertenecientes a colecciones distintas. El arquitecto, al encontrarse con que los materiales Floor Gres son perfectamente compatibles entre sí, los elige y los según sus propias exigencias.

В соответствии с подходом, преодолевающим традиционные границы и барьеры между коллекциями, Floor Gres разрабатывает цветовые гаммы на основе общего цветового плана, созданного с учетом развития стиля и тенденций в архитектуре: это - **Florim Color System**. Эта система гарантирует цветовую совместимость материалов, входящих в разные коллекции. Архитектор выбирает и сочетает материалы Floor Gres по собственному усмотрению, так как они являются совершенно совместимыми друг с другом.

INDUSTRIAL/PRODUCTINFO

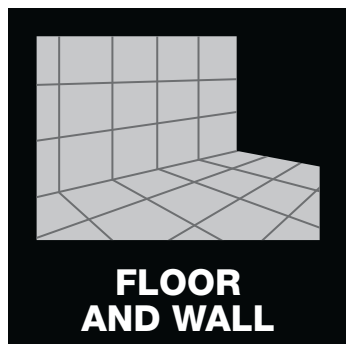

**FLOOR
AND WALL**

PAVIMENTO E RIVESTIMENTO / Prodotto con design e formati utilizzabili sia per pavimenti che per pareti.

FLOOR AND WALL / Tiles with styling and sizes suitable for both floors and walls.

CARRELAGE ET REVÊTEMENT / Produit avec design et formats utilisables aussi bien pour les sols que pour les murs.

BODENFLIESEN UND WANDFLIESEN / Design und Formate dieses Produkts eignen sich sowohl für Boden- als auch Wandgestaltung.

PAVIMENTO Y REVESTIMIENTO / Producto con diseño y formatos utilizables tanto para pavimentos como para paredes.

ПОЛ И ОБЛИЦОВКА / Изделие с дизайном и форматами, которые используются как для настила полов, так и для облицовки стен.

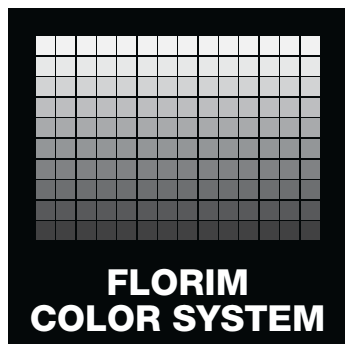

**FLORIM
COLOR SYSTEM**

SISTEMA COLORE FLORIM / Il prodotto è inserito nel grande sistema di coordinazione colore del gruppo Florim, con oltre 180 colori combinabili tra loro.

FLORIM COLOR SYSTEM / These tiles belong to Florim's great color matching system, with more than 180 colors for mixing and matching.

SYSTÈME COULEUR FLORIM / Le produit est inséré dans le grand système d'assortiment de couleurs de Florim, avec plus de 180 couleurs pouvant être coordonnées entre elles.

FARBSYSTEM FLORIM / Das Produkt ist im großen Farbstimmungssystem von Florim mit mehr als 180 kombinierbaren Farben enthalten.

SISTEMA COLOR FLORIM / Este producto forma parte del gran sistema de combinación de colores de Florim, con más de 180 colores combinables entre sí.

ЦВЕТОВАЯ СИСТЕМА FLORIM / Это изделие включено в большую систему цветовой координации группы Florim, в которую входят более 180 цветов, сочетающихся друг с другом.

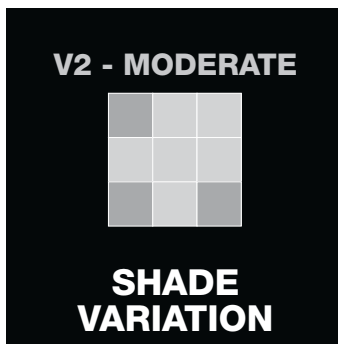

**V2 - MODERATE
SHADE
VARIATION**

GRADO DI VARIAZIONE CROMATICA / Grado di variazione nella tonalità e/o nel colore tra i vari pezzi del prodotto posato: minimo V1, massimo V4.

DEGREE OF COLOUR CHANGE / Degree of variation in the shade and/or in the colour between the various parts of the laid product: minimum V1, maximum V4.

DÉGRE DE VARIATION CHROMATIQUE / Degré de variation à la nuance et/ou de la couleur entre les diverses parties du produit étendu : minimum V1, maximum V4.

GRAD DER FARBABWEICHUNG / Grad Veränderung im Farbton und/oder der Farbe zwischen den verschiedenen Teilen des gelegten Produktes: Minimum V1, Maximum V4.

GRADO DE VARIACIÓN CROMÁTICA / Grado de variación en la cortina y/o en el color entre las varias partes del producto puesto: mínimo V1, máximo V4.

Степень изменения тона и/или цвета между различными изделиями уложенной продукции: минимум V1, максимум V4.

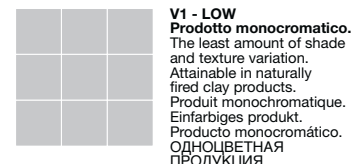

**V1 - LOW
Prodotto monocromatico.**
The least amount of shade and texture variation. Attainable in naturally fired clay products. Prodotto monocromatico. Einfarbiges Produkt. Producto monocromático. ОДНОЦВЕТНАЯ ПРОДУКЦИЯ.

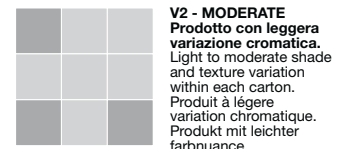

**V2 - MODERATE
Prodotto con leggera variazione cromatica.**
Light to moderate shade and texture variation within each carton. Prodotto à légère variation chromatique. Produkt mit leichter Farbnuance. Producto con una pequeña variación cromática. ПРОДУКЦИЯ С ЛЕГКИМИ ЦВЕТОВЫМИ ИЗМЕНЕНИЯМИ.

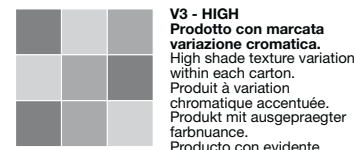

**V3 - HIGH
Prodotto con marcata variazione cromatica.**
High shade texture variation within each carton. Prodotto à variation chromatique accentuée. Produkt mit ausgeprägter Farbnuance. Producto con evidente variación cromática. ПРОДУКЦИЯ С ЯРКИМИ ЦВЕТОВЫМИ ИЗМЕНЕНИЯМИ.



**V4 - RANDOM
Prodotto con forte variazione cromatica.**
Very high shade and texture variation within each carton. Prodotto à forte variation chromatique. Produkt mit starker Farbnuance. Producto con fuerte variación cromática. ПРОДУКЦИЯ С ЯРКИМИ ЦВЕТОВЫМИ ИЗМЕНЕНИЯМИ.



IVORY

soft
matte
push-
hammered

NATURALE / SQUADRATO / R10/CLASSE B
MATTE / SQUARED / R10/CLASSE B
NATUREL / EQUARRI / R10/CLASSE B
MATT / VIERKANTIG / R10/CLASSE B
MATE / ESCUADRADO / R10/CLASSE B
НАТУРАЛЬНАЯ / КАЛИБРОВАННАЯ / R10/КЛАСС В

SOFT / SQUADRATO / R9/CLASSE A
SOFT / SQUARED / R9/CLASSE A
SOFT / EQUARRI / R9/CLASSE A
SOFT / VIERKANTIG / R9/CLASSE A
SOFT / ESCUADRADO / R9/CLASSE A
МЯГКАЯ / КАЛИБРОВАННАЯ / R9/КЛАСС А

BOCCIARDATO / SQUADRATO / R11/CLASSE C
BUSH-HAMMERED / SQUARED / R11/CLASSE C
BOUCHARDÉ / EQUARRI / R11/CLASSE C
GEHAMMERT / VIERKANTIG / R11/CLASSE C
ABUJARADO / ESCUADRADO / R11/CLASSE C
БУЧАРДНАЯ / КАЛИБРОВАННАЯ / R11/КЛАСС С

INDUSTRIAL/PRODUCT COLOURS

TAUPE

soft
matte
push-
hammered

NATURALE / SQUADRATO / R10/CLASSE B
MATTE / SQUARED / R10/CLASSE B
NATUREL / EQUARRI / R10/CLASSE B
MATT / VIERKANTIG / R10/CLASSE B
MATE / ESCUADRADO / R10/CLASSE B
НАТУРАЛЬНАЯ / КАЛИБРОВАННАЯ / R10/КЛАСС В

SOFT / SQUADRATO / R9/CLASSE A
SOFT / SQUARED / R9/CLASSE A
SOFT / EQUARRI / R9/CLASSE A
SOFT / VIERKANTIG / R9/CLASSE A
SOFT / ESCUADRADO / R9/CLASSE A
МЯГКАЯ / КАЛИБРОВАННАЯ / R9/КЛАСС А

BOCCIARDATO / SQUADRATO / R11/CLASSE C
BUSH-HAMMERED / SQUARED / R11/CLASSE C
BOUCHARDÉ / EQUARRI / R11/CLASSE C
GEHAMMERT / VIERKANTIG / R11/CLASSE C
ABUJARADO / ESCUADRADO / R11/CLASSE C
БУЧАРДНАЯ / КАЛИБРОВАННАЯ / R11/КЛАСС С

**FLOOR
GRES**

MADE IN FLORIM

MOKA

soft
matte
push-
hammered

NATURALE / SQUADRATO / R10/CLASSE B
MATTE / SQUARED / R10/CLASSE B
NATUREL / EQUARRI / R10/CLASSE B
MATT / VIERKANTIG / R10/CLASSE B
MATE / ESCUADRADO / R10/CLASSE B
НАТУРАЛЬНАЯ / КАЛИБРОВАННАЯ / R10/КЛАСС В

SOFT / SQUADRATO / R9/CLASSE A
SOFT / SQUARED / R9/CLASSE A
SOFT / EQUARRI / R9/CLASSE A
SOFT / VIERKANTIG / R9/CLASSE A
SOFT / ESCUADRADO / R9/CLASSE A
МЯГКАЯ / КАЛИБРОВАННАЯ / R9/КЛАСС А

BOCCIARDATO / SQUADRATO / R11/CLASSE C
BUSH-HAMMERED / SQUARED / R11/CLASSE C
BOUCHARDÉ / EQUARRI / R11/CLASSE C
GEHAMMERT / VIERKANTIG / R11/CLASSE C
ABUJARADO / ESCUADRADO / R11/CLASSE C
БУЧАРДНАЯ / КАЛИБРОВАННАЯ / R11/КЛАСС С

INDUSTRIAL/PRODUCT COLOURS

SAGE

soft
matte
push-
hammered

NATURALE / SQUADRATO / R10/CLASSE B
MATTE / SQUARED / R10/CLASSE B
NATUREL / EQUARRI / R10/CLASSE B
MATT / VIERKANTIG / R10/CLASSE B
MATE / ESCUADRADO / R10/CLASSE B
НАТУРАЛЬНАЯ / КАЛИБРОВАННАЯ / R10/КЛАСС В

SOFT / SQUADRATO / R9/CLASSE A
SOFT / SQUARED / R9/CLASSE A
SOFT / EQUARRI / R9/CLASSE A
SOFT / VIERKANTIG / R9/CLASSE A
SOFT / ESCUADRADO / R9/CLASSE A
МЯГКАЯ / КАЛИБРОВАННАЯ / R9/КЛАСС А

BOCCIARDATO / SQUADRATO / R11/CLASSE C
BUSH-HAMMERED / SQUARED / R11/CLASSE C
BOUCHARDÉ / EQUARRI / R11/CLASSE C
GEHAMMERT / VIERKANTIG / R11/CLASSE C
ABUJARADO / ESCUADRADO / R11/CLASSE C
БУЧАРДНАЯ / КАЛИБРОВАННАЯ / R11/КЛАСС С

**FLOOR
GRES**

MADE IN FLORIM

STEEL

soft
matte
push-
hammered

NATURALE / SQUADRATO / R10/CLASSE B
MATTE / SQUARED / R10/CLASSE B
NATUREL / EQUARRI / R10/CLASSE B
MATT / VIERKANTIG / R10/CLASSE B
MATE / ESCUADRADO / R10/CLASSE B
НАТУРАЛЬНАЯ / КАЛИБРОВАННАЯ / R10/КЛАСС В

SOFT / SQUADRATO / R9/CLASSE A
SOFT / SQUARED / R9/CLASSE A
SOFT / EQUARRI / R9/CLASSE A
SOFT / VIERKANTIG / R9/CLASSE A
SOFT / ESCUADRADO / R9/CLASSE A
МЯГКАЯ / КАЛИБРОВАННАЯ / R9/КЛАСС А

BOCCIARDATO / SQUADRATO / R11/CLASSE C
BUSH-HAMMERED / SQUARED / R11/CLASSE C
BOUCHARDÉ / EQUARRI / R11/CLASSE C
GEHAMMERT / VIERKANTIG / R11/CLASSE C
ABUJARADO / ESCUADRADO / R11/CLASSE C
БУЧАРДНАЯ / КАЛИБРОВАННАЯ / R11/КЛАСС С

INDUSTRIAL/PRODUCT COLOURS

PLOMB

soft
matte
push-
hammered

NATURALE / SQUADRATO / R10/CLASSE B
MATTE / SQUARED / R10/CLASSE B
NATUREL / EQUARRI / R10/CLASSE B
MATT / VIERKANTIG / R10/CLASSE B
MATE / ESCUADRADO / R10/CLASSE B
НАТУРАЛЬНАЯ / КАЛИБРОВАННАЯ / R10/КЛАСС В

SOFT / SQUADRATO / R9/CLASSE A
SOFT / SQUARED / R9/CLASSE A
SOFT / EQUARRI / R9/CLASSE A
SOFT / VIERKANTIG / R9/CLASSE A
SOFT / ESCUADRADO / R9/CLASSE A
МЯГКАЯ / КАЛИБРОВАННАЯ / R9/КЛАСС А

BOCCIARDATO / SQUADRATO / R11/CLASSE C
BUSH-HAMMERED / SQUARED / R11/CLASSE C
BOUCHARDÉ / EQUARRI / R11/CLASSE C
GEHAMMERT / VIERKANTIG / R11/CLASSE C
ABUJARADO / ESCUADRADO / R11/CLASSE C
БУЧАРДНАЯ / КАЛИБРОВАННАЯ / R11/КЛАСС С

**FLOOR
GRES**

MADE IN FLORIM

INDUSTRIAL/DECORSCODES

10 mm 3/8" 

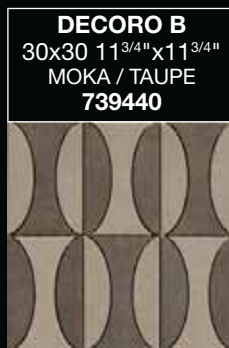

COMPOSITION/



PUZZLE DECOR

La fuga diventa decoro, la separazione della materia acquista una nuova espressività grazie alla tecnologia dell'idrogetto. Ogni realizzazione può essere unica e personalizzata in base allo spazio in cui dovrà essere inserita, il decoro può essere adattato a qualsiasi misura richiesta. Fuga tra i pezzi 1 mm. Per la realizzazione del progetto serve la pianta del cliente con indicazione precisa delle misure delle pareti da rivestire. Nel caso in cui non ci siano pareti perfettamente in squadra i pezzi ai lati saranno lasciati più lunghi di 5 cm.

Joint spaces become part of the decoration. The space that separates the material acquires a new level of expression thanks to water-jet technology. Each project can be unique and customised based on the area where it will be installed. The decoration can be adapted to any requested measurements. 1 mm joint space between tiles.

The customer's floor plan is required to design the project, providing the precise measurements of the walls where the material will be applied. If the walls are not perfectly square, the side pieces must be left 5 cm longer.

Le joint devient une décoration, la séparation de la matière acquiert une nouvelle expressivité grâce à la technologie de l'hydrojet. Toutes les réalisations peuvent être uniques et personnalisées selon l'espace où elles devront être insérées, la décoration peut être adaptée à toute mesure demandée. Joint entre les pièces 1 mm.

Pour la réalisation du projet, il faut le plan du client avec l'indication précise des mesures des murs à couvrir.

Au cas où les murs ne seraient pas parfaitement en équerre, les pièces sur les côtés seront laissées plus longues de 5 cm.

Die Fuge wird zum Dekor; die Trennung der Materie erlangt dank der Wasserstrahltechnologie eine neue Ausdruckskraft. Jede Umsetzung kann einzigartig sein und je nach Raum, in den sie eingefügt werden soll, personalisiert werden. Das Dekor kann jeder gewünschten Größe angepasst werden.

Fuge zwischen den Teilen 1 mm.

Zur Umsetzung des Projekts wird der Plan des Kunden mit genauer Angabe der Maße der zu verkleidenden Wand benötigt.

Im Falle von nicht perfekt quadratischen Wänden werden die an den Seiten befindlichen Teile 5 cm länger gelassen.

La junta se vuelve decoración, la separación de la materia adquiere una nueva expresión gracias a la tecnología de la propulsión por chorro de agua. Toda realización puede ser única y personalizada en base al espacio en el que se deberá colocar, la decoración se puede adaptar a cualquier medida requerida.

Junta entre las piezas de 1 mm.

Para llevar a cabo el proyecto es necesario contar con la planta del cliente, que indica con precisión las medidas de las paredes que hay que revestir.

En el caso en el que no se cuente con paredes perfectamente en ángulo agudo, las piezas de los lados tendrán una longitud superior a los 5 cm.

Фуга между плиткой становится декоративным элементом, благодаря гидроструйной технологии линия раздела материала приобретает новую выразительность. Каждое исполнение является уникальным и персонализированным, в зависимости от декорируемого пространства. Декорирование может осуществляться для объектов любых размеров.

Фуга между плиткой 1 мм.

Для осуществления проекта требуется план помещения клиента с указанием точных размеров стен для облицовки.

В том случае, если стены не идеально перпендикулярны и выровнены, то по бокам необходимо удлинение на 5 см.

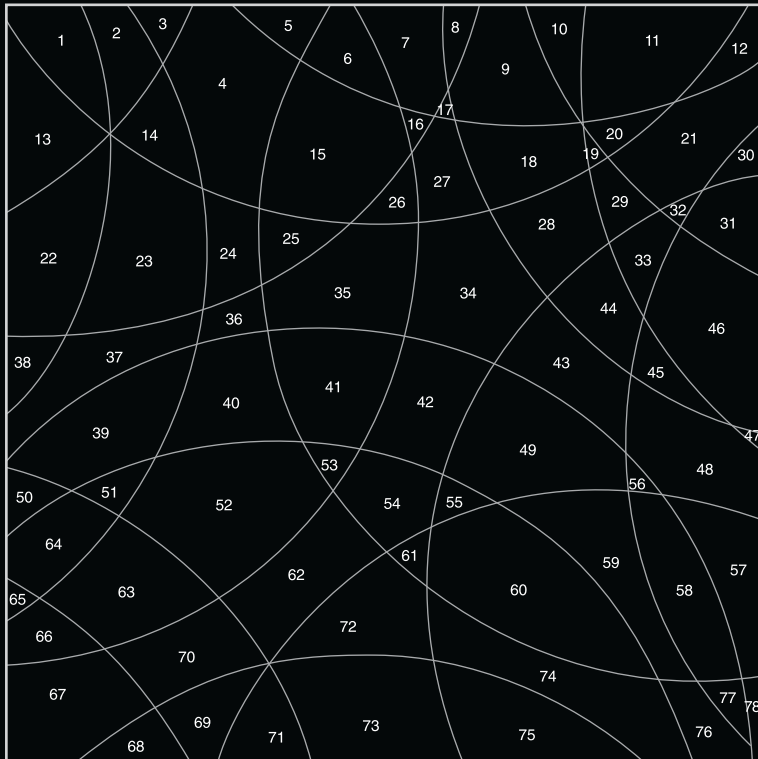

Esempio: per la realizzazione di un pannello di 160x160 cm il consumo sarà di 6 pezzi nel formato 80x80.

Example: covering a 160x160 cm panel will require the use of six 80x80 pieces.

Exemple: pour la réalisation d'un panneau de 160x160 cm, on consommera 6 pièces au format 80x80.







Beispiel: Zur Fertigung einer Platte von 160x160 cm liegt der Verbrauch bei 6 Teilen im Format 80x80.







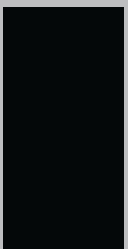

Ejemplo: para la realización de un panel de 160x160 cm el consumo será de 6 piezas en el formato 80x80.

Например: для изготовления панели 160x160 см требуется 6 шт. плитки форматом 80x80.

INDUSTRIAL/PRODUCT CODES

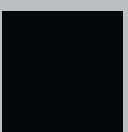





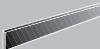
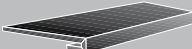
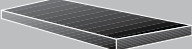
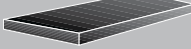
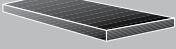

GRES FINE PORCELLANATO / FINE PORCELAIN STONWARE / GRES CERAME FIN FEINSTEINZEUG-KOLLEKTIONEN
GRES PORCELANICO FINO / ТОККИЙ КЕРАМОГРАНИТ



	60x120 23 ^{5/8} "x47 ^{1/4} "	80x80 31 ^{1/2} "x31 ^{1/2} "	40x80 15 ^{3/4} "x31 ^{1/2} "	20x80 7 ^{7/8} "x31 ^{1/2} "	60x60 23 ^{5/8} "x23 ^{5/8} "	30x60 11 ^{4/5} "x23 ^{5/8} "
						
	NATURALE / MATTE / MAT / MATT / MATE / НАТУРАЛЬНАЯ					
Spessore/Thickness Epaisseur/Dicke Espesor/Толщина						
IVORY	738816	738656	738828	738931	738803	738791
TAUPE	738819	738659	738831	738934	738807	738794
MOKA	738820	738660	738832	738935	738808	738795
SAGE	738817	738657	738829	738932	738804	738792
STEEL	738818	738658	738830	738933	738806	738793
PLOMB	738821	738661	738833	738936	738809	738796

	160x320 63"x126"	120x280 47 ^{1/4} "x110 ^{1/4} "	120x240 47 ^{1/4} "x94 ^{1/2} "	120x240 47 ^{1/4} "x94 ^{1/2} "	160x160 63"x63"	120x120 47 ^{1/4} "x47 ^{1/4} "	120x120 47 ^{1/4} "x47 ^{1/4} "
							
	NATURALE / MATTE / MAT / MATT / MATE / НАТУРАЛЬНАЯ						
Spessore/Thickness Epaisseur/Dicke Espesor/Толщина							
IVORY	744351	757774	744399	758799	744393	744405	757780
TAUPE	744352	757775	744400	758800	744394	744406	757781
MOKA	744354	757776	744402	758801	744396	744408	757782
SAGE	744353	757777	744401	758802	744395	744407	757783
STEEL	744350	757778	744398	75883	744392	744404	757784
PLOMB	744355	757779	744403	758804	744397	744409	757785

INDUSTRIAL/SPECIAL PIECES CODES

	BATTISCOPIA 4,6x60 1 ^{4/5} "x23 ^{5/8} "	GRADINO STEP 33x120x3 13"x47 ^{1/4} "x1 ^{1/6} "	ANG. GR. STEP DX 33x120x3 13"x47 ^{1/4} "x1 ^{1/6} "	ANG. GR. STEP SX 33x120x3 13"x47 ^{1/4} "x1 ^{1/6} "	ANG. GR. STEP DX/SX 33x120x3 13"x47 ^{1/4} "x1 ^{1/6} "
					
	NATURALE / MATTE / MAT / MATT / MATE / НАТУРАЛЬНАЯ				
IVORY	745535	739142	739148	739154	739422
TAUPE	745540	739145	739151	739157	739425
MOKA	745536	739146	739152	739158	739426
SAGE	745538	739143	739149	739155	739423
STEEL	745539	739144	739150	739156	739424
PLOMB	745537	739147	739153	739159	739427

60x120	80x80	40x80	20x80	60x60	30x60	60x60	30x60	30x30
23 ^{5/8} "x47 ^{1/4} "	31 ^{1/2} "x31 ^{1/2} "	15 ^{3/4} "x31 ^{1/2} "	7 ^{7/8} "x31 ^{1/2} "	23 ^{5/8} "x23 ^{5/8} "	11 ^{4/5} "x23 ^{5/8} "	23 ^{5/8} "x23 ^{5/8} "	11 ^{4/5} "x23 ^{5/8} "	11 ^{4/5} "x11 ^{4/5} "
								
SOFT / SOFT / SOFT / SOFT / SOFT / МЯГКАЯ						BOCCIARDATO/BUSH-HAMMERED BOUCHARDE/GEHAMMERT ABUJARADO / БУЧАРДНАЯ		MOSAICO TESSERE 3x3 1 ^{1/8} "x1 ^{1/8} "
10 mm 3/8"						20 mm 3/4"	10 mm 3/8"	10 mm 3/8"
738822	738662	738834	738937	738810	738797	738961	738955	739130
738825	738665	738837	738940	738813	738800	738964	738958	739133
738826	738666	738838	738941	738814	738801	738965	738959	739134
738823	738663	738835	738938	738811	738798	738962	738956	739131
738824	738664	738836	738939	738812	738799	738963	738957	739132
738827	738667	738839	738942	738815	738802	738966	738960	739135

60x120	80x80
23 ^{5/8} "x47 ^{1/4} "	31 ^{1/2} "x31 ^{1/2} "
	
NATURALE / MATTE	
744411	744381
744412	744382
744414	744384
744413	744383
744410	744380
744415	744385

15x60	15x60
6"x23 ^{5/8} "	6"x23 ^{5/8} "
MODULO LISTELLO SFALSATO MIX 3D	MODULO LISTELLO SFALSATO MIX 3D
	
SOFT / МЯГКАЯ	
10 mm 3/8"	
739191	739190
mix IVORY MOKA TAUPE	mix SAGE PLOMB STEEL

30x30	30x30
11 ^{4/5} "x11 ^{4/5} "	11 ^{4/5} "x11 ^{4/5} "
DECORO A	DECORO B
	
SOFT / МЯГКАЯ	
10 mm 3/8"	
739436 MOKA/TAUPE	739440 MOKA/TAUPE
739437 PLOMB/STEEL	739441 PLOMB/STEEL
739435 SAGE/PLOMB	739439 SAGE/PLOMB
739434 TAUPE/IVORY	739438 TAUPE/IVORY

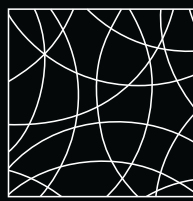

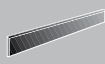
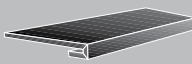
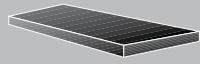
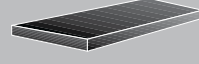
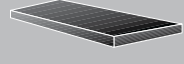
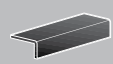
10 mm 3/8"
160x160 63"x63" 739829 PUZZLE DECOR

BATTISCOPA 4,6x60 1 ^{4/5} "x23 ^{5/8} "	GRADINO STEP 33x120x3 13"x47 ^{1/4} "x1 ^{1/6} "	ANG. GR. STEP DX 33x120x3 13"x47 ^{1/4} "x1 ^{1/6} "	ANG. GR. STEP SX 33x120x3 13"x47 ^{1/4} "x1 ^{1/6} "	ANG. GR. STEP DX/SX 33x120x3 13"x47 ^{1/4} "x1 ^{1/6} "	ELEMENTO ELLE 15x60x6 6"x23 ^{5/8} "x2 ^{1/3} "
					
SOFT / SOFT / SOFT / SOFT / SOFT / МЯГКАЯ					BOCCIARDATO/BUSH-HAMMERED BOUCHARDE/GEHAMMERT ABUJARADO / БУЧАРДНАЯ
745541	739160	739166	739172	739428	739136
745546	739163	739169	739175	739431	739139
745542	739164	739170	739176	739432	739140
745544	739161	739167	739173	739429	739137
745545	739162	739168	739174	739430	739138
745543	739165	739171	739177	739433	739141

INDUSTRIAL/TECHNICAL INFO # 2 CM

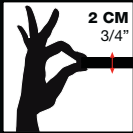

Vantaggi tecnici • Technical advantages • Avantages techniques Technische Vorteile • Ventajas técnicas • Технические преимущества



- Lastra monolitica compatta di spessore 2 cm squadrata e rettificata
- Compact monolithic slab 2 cm thick squared and rectified
- Dalle monolithique compacte de 2 cm d'épaisseur, équarrie et rectifiée
- Kompakte monolithische Platte, 2 cm dick, rechteckig und scharfkantig geschliffen
- Losa monolítica compacta de 2 cm de espesor, escuadrada y rectificada.
- Монолитная плотная плита толщиной 2 см, с обрезанными и выровненными кромками



- INGELIVO
- FROST RESISTANT
- INGÉLIF
- FROSTBESTÄNDIG
- RESISTENTE A LA HELADA
- МОРОЗОСТОЙКАЯ

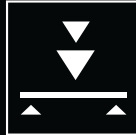

- ELEVATA RESISTENZA AI CARICHI STATICI
- HIGH STATIC LOAD RESISTANCE
- RÉSISTANCE ÉLEVÉE AUX CHARGES STATIQUES
- HOHE STATISCHE BELASTBARKEIT
- ELEVADA RESISTENCIA A LAS CARGAS ESTÁTICAS
- ВЫДЕРЖИВАЕТ БОЛЬШИЕ СТАТИЧЕСКИЕ НАГРУЗКИ



- FACILE DA POSARE
- EASY TO INSTALL
- FACILE À POSER
- VERLEGELEICHT
- FÁCIL DE COLOCAR
- ЛЕГКО УКЛАДЫВАЕТСЯ



- ANTISCIVOLO R11 CLASSE C
- ANTI SLIP R11 CLASS C
- ANTIDÉRAPANT R11 CLASSE C
- RUTSCHFEST R11 KLASSE C
- ANTIDESLIZANTE R11 CLASE C
- НЕКОЛЬЗКАЯ - R11 КЛАСС C

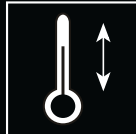

- RESISTENTE AGLI SBALZI TERMICI
- THERMAL SHOCK RESISTANT
- RÉSISTANT AUX ÉCARTS THERMIQUES
- TEMPERATURWECHSELBESTÄNDIG
- RESISTENTE A LAS OSCILACIONES TÉRMICAS
- СТОЙКАЯ К ТЕПЛОВЫМ ПЕРЕПАДАМ



- FACILE DA PULIRE
- EASY TO CLEAN
- FACILE À NETTOYER
- REINIGUNGSLEICHT
- FÁCIL DE LIMPIAR
- ЛЕГКО ЧИСТИТСЯ

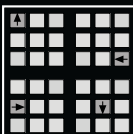

- RIMOVIBILE E RIUTILIZZABILE
- REMOVABLE AND REUSABLE
- DÉMONTABLE ET RÉUTILISABLE
- ENTFERNBAR UND WIEDERVERWENDBAR
- DESMONTABLE Y REUTILIZABLE
- МОЖЕТ СНИМАТЬСЯ И ПОВТОРНО ИСПОЛЬЗОВАТЬСЯ



- INATTACCABILE DA AGENTI CHIMICI E MUFFE
- IMPERVIOUS TO ATTACK BY CHEMICALS OR MOULD
- RÉSISTANT AUX AGENTS CHIMIQUES ET AUX MOISSISSURES
- UNANGREIFBAR DURCH CHEMISCHE STOFFE UND SCHIMMEL
- RESISTENTE A LOS AGENTES QUÍMICOS Y A LOS MOHOS
- НЕ ПОДВЕРГАЕТСЯ ВОЗДЕЙСТВИЮ ХИМИЧЕСКИХ ВЕЩЕСТВ И ПЛЕСЕНИ

Applicazioni • Applications • Applications • Verlegung • Aplicaciones • Применения

- Posa diretta su erba
- Direct installation on grass
- Pose direct sur de l'herbe
- Verlegung direkt auf Rasen
- Colocación directa sobre hierba
- Прямая укладка на траву

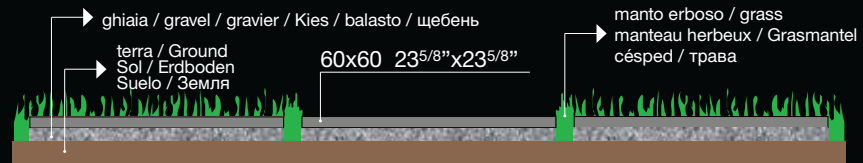

- Posa diretta su ghiaia
- Direct installation over gravel
- Pose direct sur du gravier
- Verlegung direkt auf Kies
- Colocación directa sobre grava
- Прямая укладка на гальку

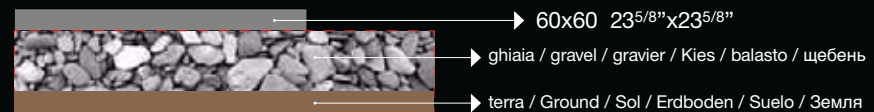

- Posa su massetto cementizio
- Installation on sand-cement screed
- Pose sur chape ciment
- Verlegung auf Zement-Unterbetonblock
- Colocación sobre contrapiso de hormigón
- Укладка на цементную стяжку

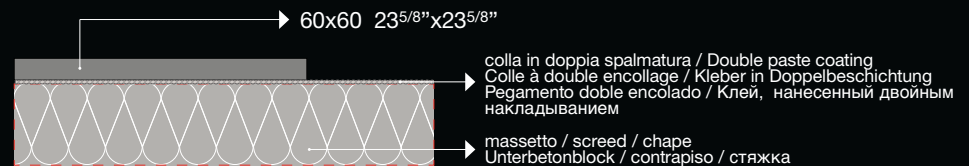

- Posa su piedini fissi o regolabili
- Installation on fixed or adjustable feet
- Pose sur pieds fixes ou réglables
- Verlegung auf feststehende oder regulierbare Füße
- Colocación sobre pies fijos o regulables
- Укладка на фиксированных или регулируемых ножках

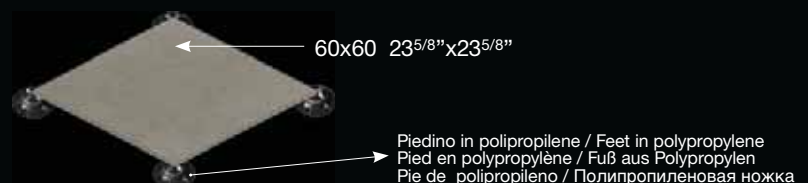

N.B. Le lastre ceramiche sono sottoposte a un trattamento di compattazione termica che assicura resistenza e durata nel tempo. Il bassissimo assorbimento d'acqua rende perciò il materiale ingelivo. Ciò può comportare ristagni d'acqua superficiali anche per materiale installato a regola d'arte. / Ceramic tiles undergo a compacting thermal treatment that ensures resistance and durability. The low level of water absorption makes the slabs frost resistant. This could result in superficial water stagnations even if materials are installed in a workmanlike manner. / Les carreaux de céramique subissent un traitement thermique de compactage qui assure résistance et durabilité. Le bas niveau d'absorption d'eau rend les dalles résistant au gel. Il pourrait en résulter des stagnations d'eau superficielles, même si les dalles ont été installées dans les règles de l'art. / Die Keramikplatten werden einer thermischen Verdichtung unterzogen, welche die Widerstandsfähigkeit und Langlebigkeit sichert. Die extrem niedrige Wasseraufnahme macht das Material frostsicher. Die hohe Materialdichte kann, auch bei einer perfekten Verlegung, eine längere Abtrocknungszeit von angestaumtem Wasser zur Folge haben. / Las baldosas cerámicas se someten a un tratamiento de compactación térmica que asegura resistencia y durabilidad. La baja absorción de agua hace que las baldosas resistan al hielo. Esto podría resultar en estancamientos superficiales de agua, incluso si los materiales están instalados según las reglas del arte. / Керамическая плитка подвергается термическому уплотнению, что обеспечивает ей прочность и износостойкость. За счёт очень низкого водопоглощения она не промерзает, при этом даже при правильной укладке возможны застои воды на поверхности плитки.

Per le specifiche di utilizzo dei sistemi sopraelevati vedi il sito www.florim.com / For the specifics on use of raised systems visit the site www.florim.com / Pour les caractéristiques d'utilisation des systèmes surélevés, voir le site www.florim.com / Für die Nutzungsbedingungen der Doppelbodensysteme siehe Webseite www.florim.com / Para las especificaciones de empleo de los sistemas sobreelevados consulte el sitio web www.florim.com / Технические характеристики систем фальшполов см. на сайте www.florim.com



放射性水平 A 类

Certificazione obbligatoria per l'esportazione in Cina
Certification mandatory for export to China
Certification obligatoire pour l'exportation en Chine
Für den Export nach China obligatorische Zertifizierung
Certificación obligatoria para la exportación a China
Обязательная сертификация для экспорта в Китай



FLORIM Ceramiche S.p.A SB. a socio unico
Via Canaletto, 24 - 41042 Fiorano Modenese (MO) - Italia

05

FLORIM 001

EN 14411:2012

Dry-pressed ceramic tiles, with water absorption $E_b \leq 0,5 \%$,
for internal and external walls and floorings

Per informazioni relative ai dati tecnici su marcatura CE vedere il sito www.florim.com
Please refer to our web site www.florim.com for technical information related to CE labeling
Pour tout renseignement sur l'avis technique de la marque CE veuillez consulter le site www.florim.com
Informationen bezüglich technischer Daten zur Beschriftung CE entnehmen Sie unserer Website www.florim.com
Para informaciones relativas a las especificaciones técnicas sobre la marca CE, chequear el sitio www.florim.com
ИНФОРМАЦИЯ ПО ТЪХ. ЦКННЫМ. ОТНОСЯЩИМСЯ К МКРКИРОНЪКЪ "СЕ" ПРИНЪЦЪНК НК СКИТЬ www.florim.com

FLORIM OVERSIZE
magnUm

FLORIM Ceramiche S.p.A SB. a socio unico
Via Canaletto, 24 - 41042 Fiorano Modenese (MO) - Italia

09

FLORIM 003

EN 14411:2012

Dry-pressed ceramic tiles, with water absorption $E_b \leq 0,5 \%$,
for internal and external walls and floorings

Per informazioni relative ai dati tecnici su marcatura CE vedere il sito www.florim.com
Please refer to our web site www.florim.com for technical information related to CE labeling
Pour tout renseignement sur l'avis technique de la marque CE veuillez consulter le site www.florim.com
Informationen bezüglich technischer Daten zur Beschriftung CE entnehmen Sie unserer Website www.florim.com
Para informaciones relativas a las especificaciones técnicas sobre la marca CE, chequear el sitio www.florim.com
ИНФОРМАЦИЯ ПО ТЪХ. ЦКННЫМ. ОТНОСЯЩИМСЯ К МКРКИРОНЪКЪ "СЕ" ПРИНЪЦЪНК НК СКИТЬ www.florim.com



Sistema di gestione della Qualità:
Certificato n°. 50 100 1271

Sistema di gestione dell'Ambiente:
Certificato n°. 50 100 100 74

Sistema di gestione della Salute e Sicurezza dei lavoratori:
Certificato n°. 50 100 13825

Sistema di gestione dell'Energia:
Certificato n°. 50 100 13545



**FLOOR
GRES#**

MADE IN FLORIM

FLORIM CERAMICHE S.p.A. SB. a socio unico

sede legale: via canaletto 24 / 41042 fiorano modenese mo italy / t. +39 0536 840111 / f. +39 0536 844750 / w. florim.com